

**Honeywell**

# ScanPal EDA70

Enterprise Tablet  
with Android™ 7.1 Operating System



**User Guide**

## **Disclaimer**

Honeywell International Inc. (abbr. HII) reserves the rights to modify the specifications and other information mentioned in this User Guide without prior notification. In any case, users should confirm with HII whether any changes were made. This publication does not represent any commitments of HII.

HII is not responsible for any technical or editing errors or omissions contained in this manual, nor for any incidents or indirect damages caused by providing, implementing or using this material. HII is not responsible for the software and/or hardware selected or used in order to achieve the desired results.

The proprietary information contained in this article is protected by copyright. All rights reserved. Without prior written consent from HII, any form of photocopy, copy or translation into other languages is not allowed.

## **Trademark Rights**

Android, Google and other marks are trademarks of Google Inc.

Other product names mentioned in this manual may be trademarks or registered trademarks of their respective companies, which are owned by these companies.

## **Patents**

For information on patents, please refer to [www.hsmpats.com](http://www.hsmpats.com).

Copyright © 2017 Honeywell International Inc. All rights reserved.

# Table of Contents

<b>1</b>	<b>Product Features of ScanPal Series EDA70-X Terminal</b> .....	<b>1</b>
	About EDA70-X Terminal.....	2
	Battery.....	6
	Charging.....	6
	Replacing batteries.....	7
	Battery icon.....	10
	Changing power indicators.....	12
	Checking the remaining battery capacity.....	13
	Battery life and maintenance.....	13
	Battery maintenance recommendations and safety protection measures.....	14
	Charging While in Use.....	15
	Enabling Airplane mode.....	16
	Powering on.....	17
	Unlocking the screen.....	17
	Scanning Indicator.....	18
	Setting screen backlight.....	19
	Audio features.....	19
	Adjusting the ringtone volume for calls and messages.....	19
	Enabling vibration mode.....	21
	Audio settings.....	22
	Inserting SD card.....	23
	File transfer.....	24
	How to view files on EDA70-X.....	24
	EDA70-X Accessories.....	25
<b>2</b>	<b>User interface and applications</b> .....	<b>26</b>
	User interface.....	27
	The main interface.....	27
	Navigation and function keys.....	29
	Status bar icons.....	29
	KeyRemap.....	30
	Viewing system messages.....	31
	Managing system messages.....	31
	Personalizing the main interface.....	32
	Customizing common applications.....	32
	Using Google™ Search.....	32
	Touch screen gestures.....	33
	Setting timezones.....	33
	Honeywell applications.....	34
	Download Enterprise Application Lock (Applock).....	36
	User Guide for ScanPal Series Terminal.....	iii

## Table of Contents

Unlocking developer options .....	36
GMS.....	36
<b>3 Scan Function .....</b>	<b>37</b>
Scan Function.....	38
How to transfer data via Android keyboard input .....	38
Changing scan settings.....	39
Restoring default scan settings.....	40
Scanner default settings .....	40
Scanning barcodes .....	46
<b>4 Using Telecommunication Function .....</b>	<b>47</b>
Telecommunication Function.....	48
Activating calls .....	48
Making a call .....	49
Answering a call.....	49
Switching applications during a call.....	49
Making an emergency call.....	50
Configuring call settings.....	50
<b>5 Using Camera .....</b>	<b>51</b>
Color camera.....	52
Adjusting camera and video settings.....	52
Zooming.....	52
Changing camera settings.....	52
Taking photos.....	52
Shooting videos .....	53
Changing video settings .....	53
<b>6 Configuring Terminal .....</b>	<b>54</b>
Terminal configurations .....	55
Setting launch applications.....	55
Structure of the Application Settings .....	55
Network communication .....	59
Connecting to Wi-Fi networks .....	59
Connecting to a virtual private network.....	62
Wireless Security.....	63
Certificates .....	63
Bluetooth communication.....	65
Pairing with a Bluetooth-enabled device.....	65
Configuring Bluetooth settings .....	67
Searching for EDA70-X.....	67
Renaming or disconnecting a paired device .....	67
Communication via USB.....	68
Near Field Communication.....	68

<b>7</b>	<b>Management and Maintenance .....</b>	<b>69</b>
	Upgrading system software .....	70
	Upgrading AutoInstall application .....	70
	Upgrading composite key.....	70
	Manually upgrading Recovery Menu .....	70
	Restarting the Terminal .....	71
	Restarting the system.....	71
	Restore factory settings.....	72
	Cleaning the terminal.....	72
<b>8</b>	<b>Specifications .....</b>	<b>73</b>
	Mechanical and environmental specifications .....	73

# Technical Support

If you need installation or troubleshooting help, please contact us via:

Knowledge base: [www.hsmknowledgebase.com](http://www.hsmknowledgebase.com)

Honeywell knowledge base provides thousands of turnkey solutions. If the knowledge base can't help you solve your problems, you can submit your questions or ask question on Honeywell technical support website.

Technical support website: [www.hsmsupportportal.com](http://www.hsmsupportportal.com)

Login Honeywell technical support website to search for knowledge base, submit your difficulties or questions, ask for call-back services or provide feedbacks. Please provide more detailed information when filling the forms. You can also upload attachments for explanation.

Contacts: [www.honeywellaidc.com/locations](http://www.honeywellaidc.com/locations)

For the latest contacts, please visit our website.

## Product Service and Maintenance

Honeywell International Inc. provides services for all of its products all over the world via its service centers. For information about the site of service centers, please visit [www.honeywellaidc.com](http://www.honeywellaidc.com) and select English as preferred language, then select **Support > Contact Support > Service and Maintenance**. Please contact our service center to get RMA (Return Material Authorization) numbers before sending the products for maintenance.

To get Honeywell service during warranty or out of warranty, please send the product together with the purchase date records to Honeywell service center (postage paid)

## Limited Warranty

For information about the warranty, please visit [www.honeywellaidc.com](http://www.honeywellaidc.com) and select English as preferred language, tap **Resources > Warranty**.

## Feedback

Your feedback is very important for us to improve the quality of documentation. Please contact Technical Communication Departments to submit your feedback on the User Guide: [ACSHSMTechnicalCommunications@honeywell.com](mailto:ACSHSMTechnicalCommunications@honeywell.com).

# **1 Product Features of ScanPal Series EDA70-X Terminal**

This chapter is about ScanPal series EDA70-X (X refers to 0 and 3, as in all other cases below) terminal (hereinafter called “EDA70-X” or “terminal”) equipped with Android 7.1 OS. Information will be given on the terminal’s basic features, functions and accessories.

## About EDA70-X Terminal

Honeywell EDA70-X tablet is an enterprise-focused tablet that uses the Android operating system to provide reliable and secure management of corporate data and wireless communication. The main features of EDA70-X are: large-screen display, high-capacity battery, bar code imager and Rugged durability.

- Android™ 7.1 OS.
- 2 GB dynamic RAM, 16GB flash memory.
- Large display with sensitive multi-touch screen.
- High-performance area imaging features with an ergonomic scan trigger.
- WCDMA / GSM wireless WAN communications ensure high-speed data transmission and high-fidelity sound support for all network technologies.
- IEEE 802.11a/b/g/n.
- Bluetooth 4.0.
- Near-field communication (NFC) technology for short-range wireless data transmission.
- High value-added software components support professional imaging and optical character recognition (OCR) features.
- Mid-tier rugged specifications with IP64 sealing.
- Reliable Micro SD slot that supports up to 32GB expansion.
- Integrated GPS receiver.
- 5 mega pixels color camera.



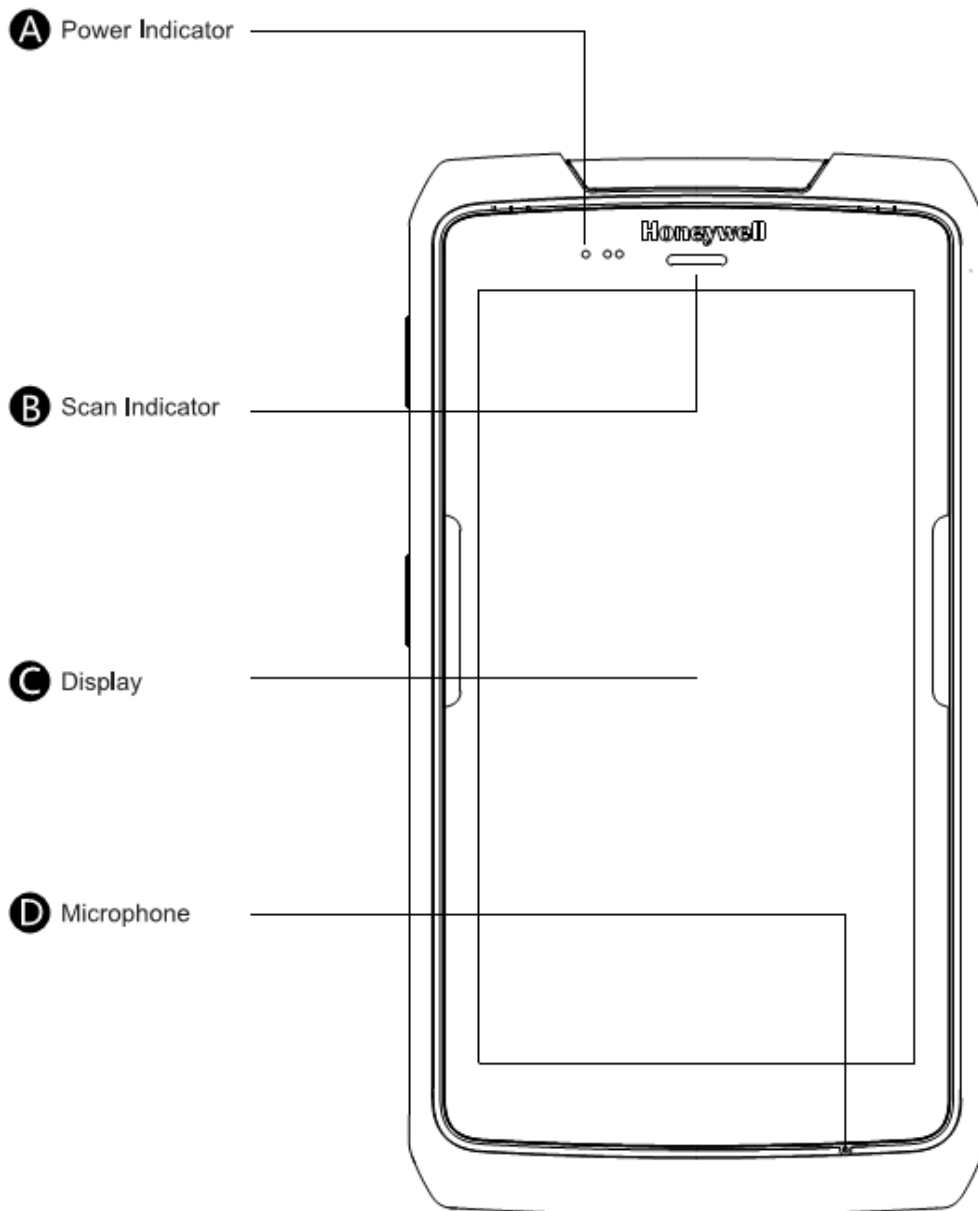

Front view of the EDA70-X

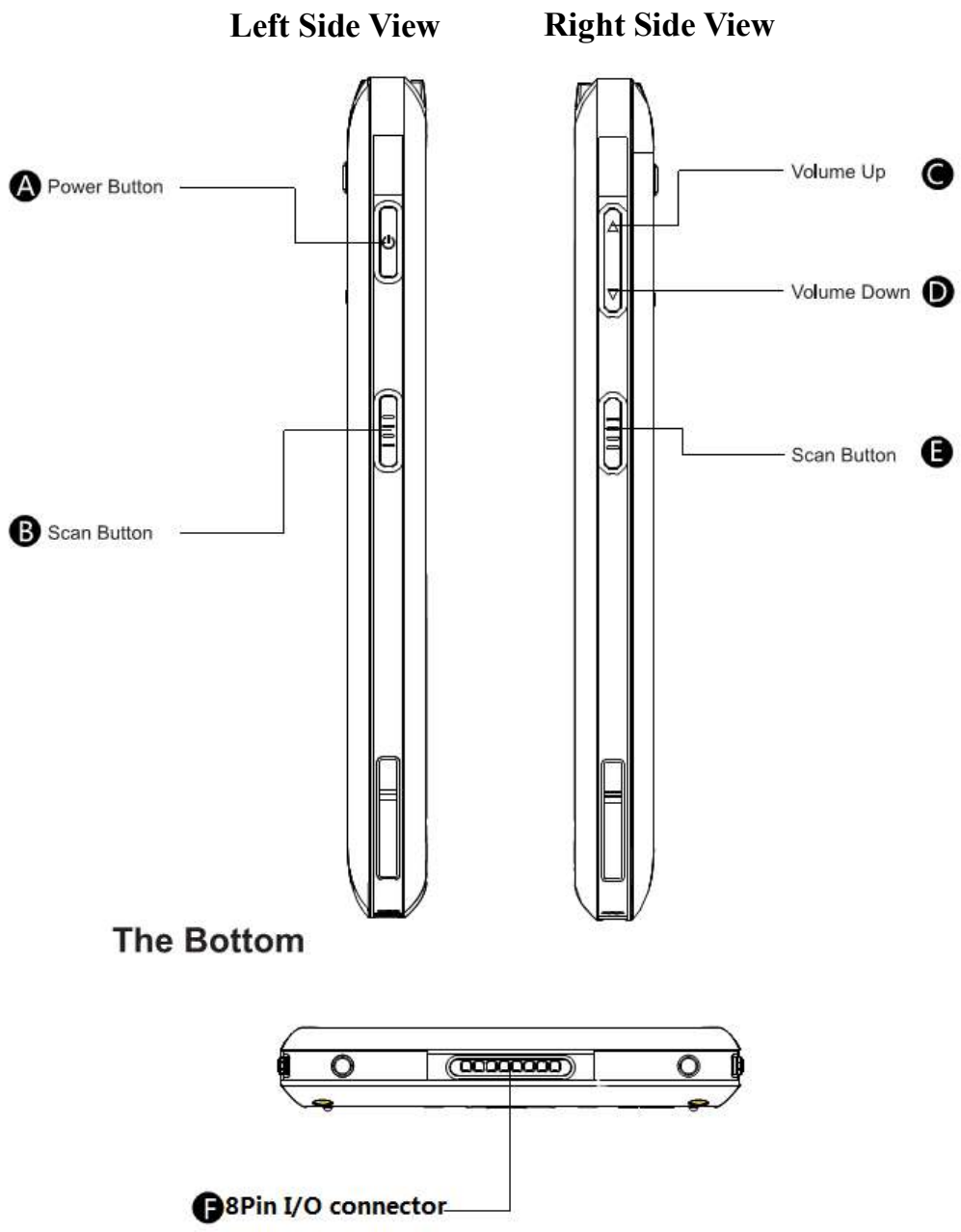

Side and bottom views of the EDA70-X

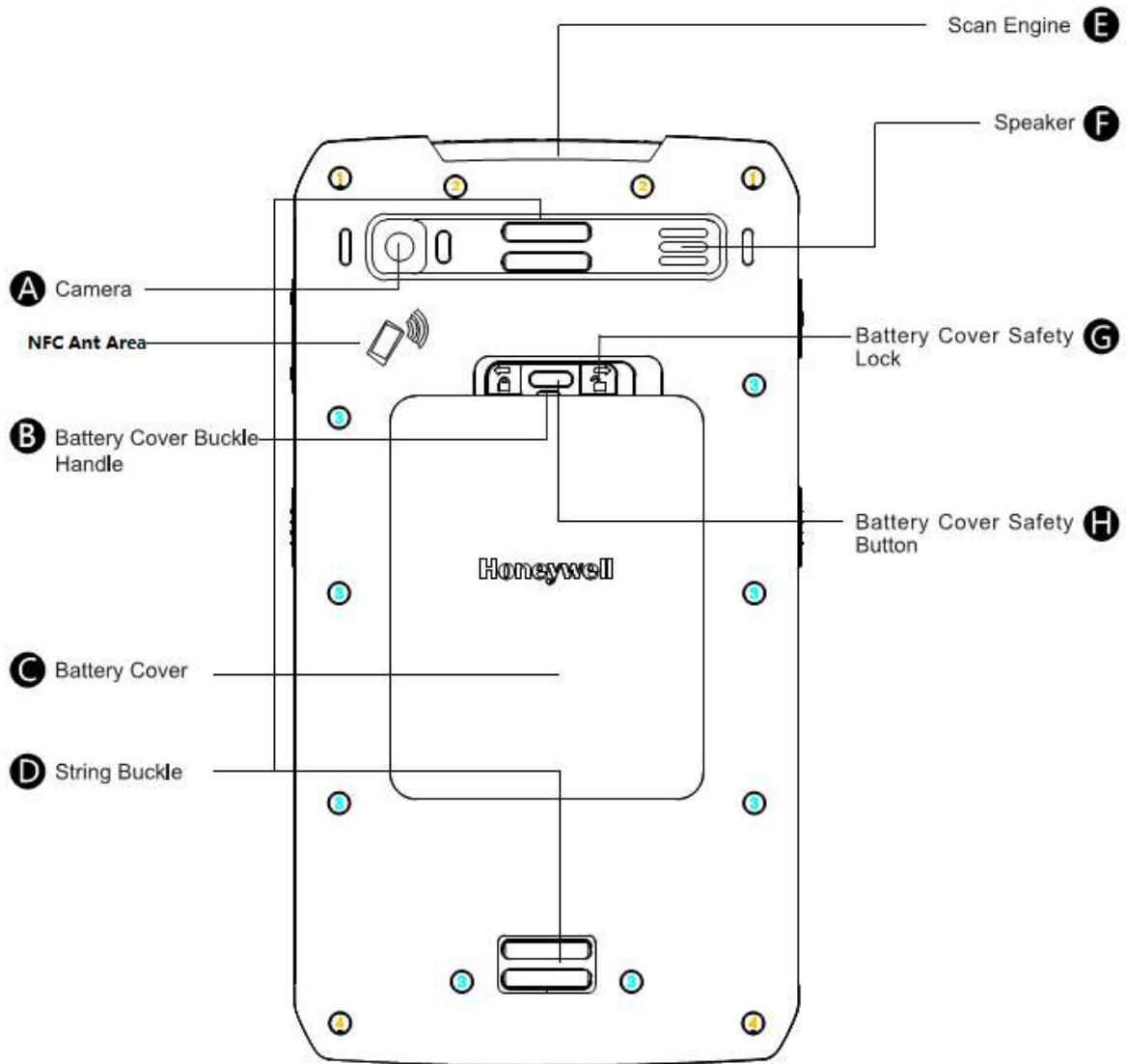

Back view of the EDA70-X

## Battery

EDA70-X uses 3.8V rechargeable lithium ion battery as its main power supply. The battery capacity is watt hour. Battery life is influenced by many factors, such as: screen brightness, the length of time before the screen automatically go to sleep, input configurations, extreme temperature and using behaviors, etc.

Honeywell suggests you to keep the battery charged to avoid data loss. Change battery only after switching off the device as per normal. Switch on the device after completing change of battery.

If you need to buy a rechargeable battery, please contact regional resellers.



**Warning: Improper use of the battery of this device can cause a fire or chemical burns. Please don't disassemble the battery or heat it to 100 °C (212 °F) and above, or incinerate the battery. Make sure waste batteries are properly disposed. Keep out of reach of the children.**

**We would recommend using only Honeywell's lithium battery; any damage caused by use of non-Honeywell battery is not covered by warranty.**

## Charging

Before using EDA70-X, you need to make sure the battery (model number for North America: BAT-EDA50US; model number for other regions: BAT-EDA50) is fully charged. You can charge the battery before or after installing it to EDA70-X. It will take about 5 hours for the battery to be fully charged using original quad charger (cradle charger or otherwise).

**We would recommend using Honeywell's original charger; any damage caused by use of non-Honeywell charger is not covered by warranty**

## Replacing batteries

When the battery power is low, you can charge it together with the terminal, or replace it with a fully-charged battery.

1. Save all the files and close all running Apps.
2. Long press the power key. Until the follow interface pop up:

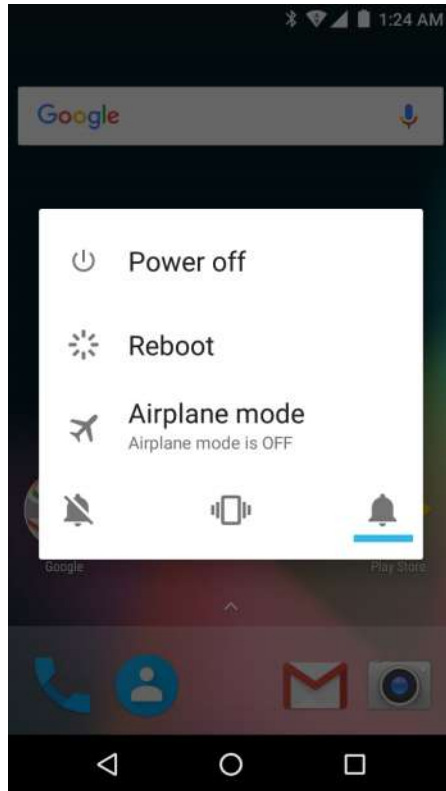

3. Tap Power off.
4. EDA70-X will power off directly.

## Chapter 1: Product Features of ScanPal Series EDA70-X Terminal

After it's turned off, do as the following instructions manually:

1. Press down the battery cover safety button to move the lock to the unlock position at right;

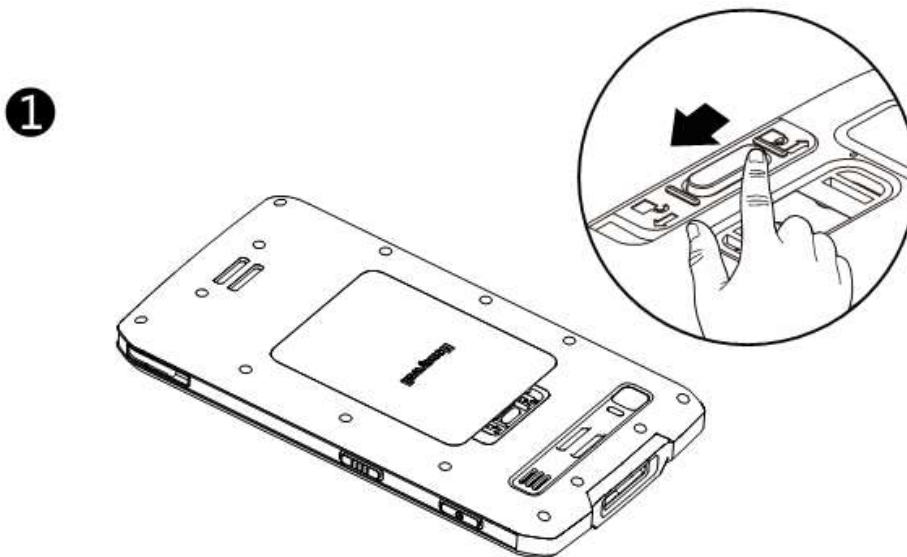

2. Open the battery cover with the battery cover buckle;

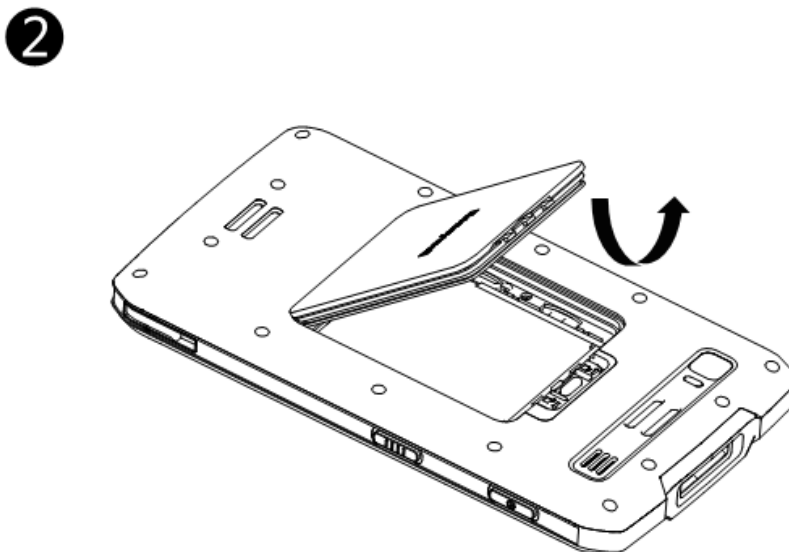

## Chapter 1: Product Features of ScanPal Series EDA70-X Terminal

3. Insert the battery (Insert the non-connector side first, then press the battery down to establish connection between the battery and the phone). Press down the battery cover.

**3**

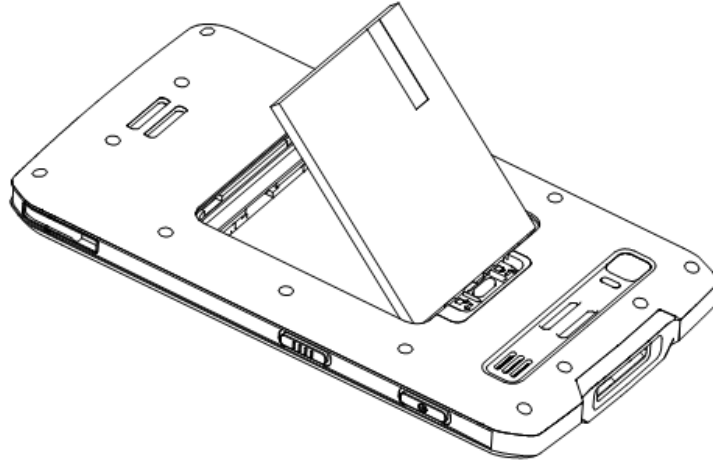

4. Press down the battery cover

**4**

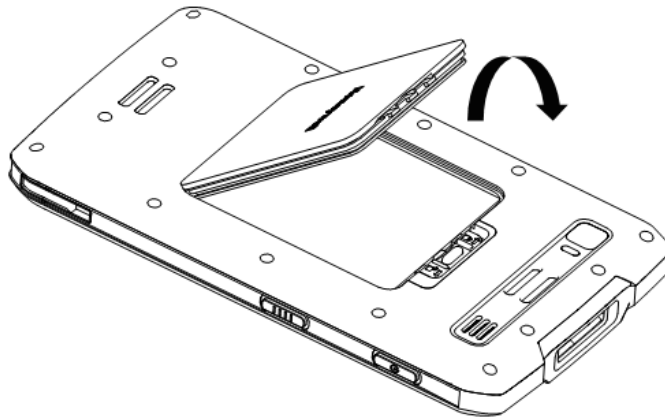

5. Press down the battery cover safety button to move the battery cover safety lock to the lock position at left

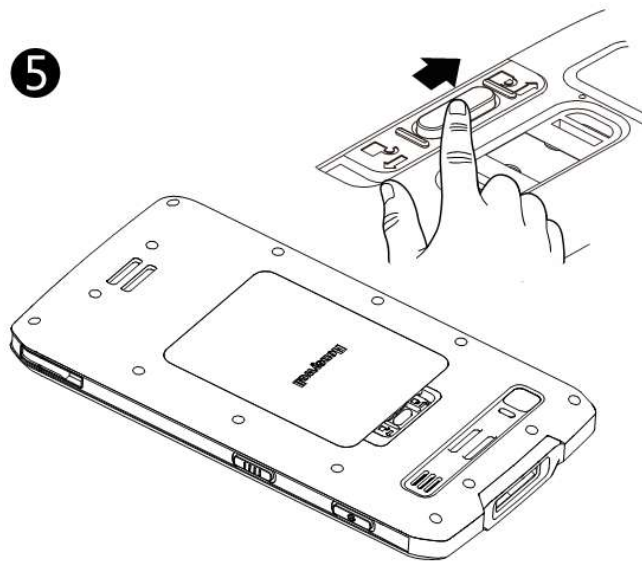

## Battery icon

Battery icon on the status bar shows the power status of the battery. The following table only contains several of the icons. For detailed information about battery life and power remained, please go to **Settings > Battery**.

### Battery icon

Icon	Status
	Battery power is 100% full
	Battery power is 50% full
	Battery power is too low. Replacing the battery right now.
	The terminal has been connected to external power supply for charging.
	Battery failure occurs. Please replace the battery. If the failure still exists, please contact Honeywell technical support.



Power indicator on the upper left corner of the terminal shows the battery charging status. It can also be used as system message indicator. For detailed setting methods, please refer to <http://developer.android.com/guide/topics/ui/notifiers/notifications.html>.

### Default power indicator description

Connect to power supply	Indicator status	Description
No	Flashing amber (Orange)	Battery power is less than 15% full
No	No light	Battery power is higher than 15% full
Yes	Stable amber (Orange)	Battery power is between 0% to 60% full
Yes	Flashing green	Battery power is between 60% to 95% full
Yes	Stable green	Battery power is higher than 95% full
Yes/no	Flashing red	Battery failure

## Changing power indicators

If the default indicators for battery charging (flashing green) is inappropriate for your environment, you can change the indicator.

In addition to changing the default power indicator, you can also select:

- Default Battery LED
- No Battery LED

If you prefer the indicator to be solid amber and to change to solid green when in charging, you need to perform **Default Battery LED** settings. If you prefer the indicator as message notification (application or device management solution notification) indicator, you need to select **No Battery LED** settings.

### Default power indicator meanings

Connect to power supply	Indicator status	Description
No	Flashing red	Battery power is less than 15% full
No	No light	Battery power is 15% or more
Yes	Stable red	Battery power is less than 15% full
Yes	Stable amber	Battery power is between 15% to 90% full
Yes	Stable green	Battery power is over 90% full

1. Tap **Settings> Honeywell Battery LED**
2. Select from the following options:
  - Default Battery LED
  - HSM Battery LED (Factory settings)
  - No Battery LED

## Checking the remaining battery capacity

Except for the battery icon and power indicator, you can also get the battery capacity information from Settings.

1. Tap **Settings**
2. Tap **Battery**. The current percentage of remaining battery capacity and the remaining time will be displayed. The list will present the power consumed by each application and service. For detailed usage information, please tap the respective applications and services in the list.

## Battery life and maintenance

### Tips for battery maintenance

The expected life of the battery is approximately 500 cycles, or about two years, if care is taken in charging. Follow these guidelines to maximize life span.

When this happens	Do this:
The low power icon is displayed or the power indicator lights when the terminal is in use	Power off the terminal. Long press the power key and choose Turn Off.
The terminal is to be charged unused overnight or over a weekend	Power off the terminal to maximize battery cycle lifespan.
The terminal is to be charged while in use	Once it is close to a full charge, avoid continuously charging the terminal while operating to maximize lifespan. Remove the terminal from the charging source during operation. See the chapter on "Charging While in Use" for more information.
The terminal will be unused for more than a few minutes	Make sure the low power icon and power indicators are not on. Switch to sleep mode by pressing the Power key.
	The battery will discharge slowly if it is removed from the terminal.
The terminal will be stored for more than one day	To store the terminal for several days (such as a weekend), install a fully charged battery or connect the terminal to the power supply and turn off the terminal.

When this happens	Do this:
	<p>If you need to store it for a longer time, remove the battery and charge it. Put the terminal and the battery in a cool place after the battery is fully charged.</p> <p>If the battery is to be stored for several months, regular charging is recommended for optimal battery performance.</p>

### Battery maintenance recommendations and safety protection measures

- Fully charge the battery before use. The battery is only partly charged when initially shipped.
- Refer to the chapter "charging" to get the right process for battery charging. Using the battery for other devices may cause damages on the device or the battery.
- Avoid dropping the battery or the terminal. If you suspect that a battery or terminal has failed, send it to Honeywell service center for verification.
- This battery should only be replaced by another Honeywell BAT-EDA50 battery. These batteries have been tested and meet the appropriate safety standards.
- Before recycling the battery, cover the contacts with insulation tape.
- Do not modify the battery or attempt to insert foreign objects into the battery.
- Do not solder directly to the battery poles.
- Do not short connect the battery and keep the battery away from metal objects.
- Do not drop or mechanically shock or extrude the battery.
- Do not disassemble or open the battery. Do not crush, bend or deform the battery; Do not puncture, shred or burn the battery.
- Do not immerse the battery in water.
- Avoid extreme temperature conditions such as found on the dash of a car in the sun or near a heat source such as a stove or open flame. After extreme low or high temperature exposure, allow the terminal and battery to come to room temperature before charging

### Charging While in Use

Avoid charging the terminal continuously while in use to maximize battery cycle life. Battery health is maximized when the terminal is turned off or is in the Suspend state during charging.

Suspend (or “sleep”) is an ultra-low-power state where the main processor and display are powered off to minimize power consumption. Under factory settings, the terminal automatically enters the Suspend state after a brief period of non-use. However, certain software applications or configuration settings can keep the terminal awake.

If the terminal does not Suspend within the expected time limit, **do not** leave the terminal in the charger. Check the application and application settings to determine if they are preventing the unit from entering the suspend state. Update to the latest system software.

Software version 207.01.00.0016 and above includes a special feature designed to protect against battery damage due to continuous charging during use. This software optimizes charging behavior based on whether the terminal is in the Suspend state or not.

- **Charging while awake:** If the terminal is awake, that is, not off or in the suspend state, the charging system enters a special charging mode that adjusts voltage thresholds to avoid overcharging. In this mode, the battery charge is maintained between 80% and 90%. NOTE: This means that the battery will not be at 100% after a full night's charge.
- **Charging while off or in Suspend:** In contrast, if the computer is off or in the Suspend state, the special charging mode is not invoked, and the battery level is maintained close to 100%.

This logic protects the battery from damage and maximizes battery cycle life.

## **Enabling Airplane mode**

If you don't need to connect to any wireless network, you can enable the airplane mode to turn off all wireless receivers to save power.

1. Tap **Settings**.
2. In the Wireless & Networks section, tap More.
3. Tap the toggle box to enable Airplane Mode.

## Powering on

After the battery is fully charged and installed into ScanPal EDA70-X, turn on it for the first time:

Press down and then release the **power** key.



**Please note:** after complete the installation instructions, the welcome interface will not appear again. The interface appears as locked screen interface after each time you turn on the terminal.

## Unlocking the screen

Every time you turn on the terminal, you need to unlock the screen.

- Slide the lock icon to any edge of the screen to unlock it.

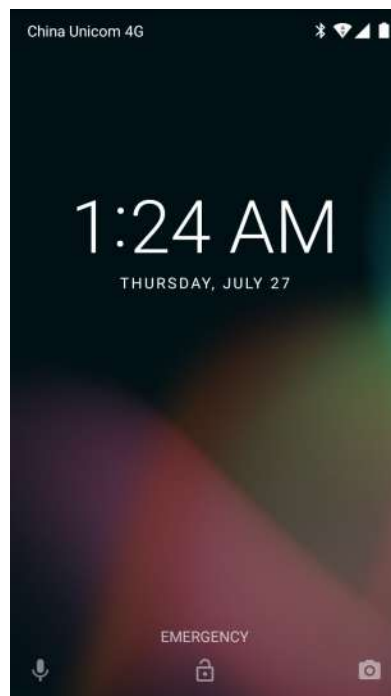

- After the EDA70-X is deployed, we suggest you to set password to protect your terminal.

Tap **Settings>Security>Screen lock**.

Options are Pattern, PIN, Password.

## Scanning Indicator

The scanning indicator indicates the status of the scanner. For barcode scanning method, please refer to the chapter "Scanning barcodes".

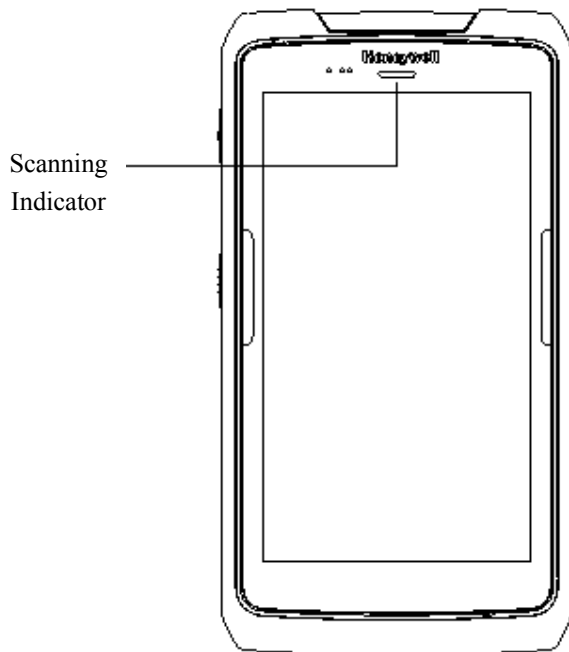

### Scanning indicator definition

Light of the indicator	Meanings
Green	Good read for the barcodes
Red	Barcodes reading failed



## Setting screen backlight

The terminal's screen is equipped with background light sensor which can automatically adjust backlight intensity to save power and ensure the display readability. You may set the backlight intensity based on the environment.

1. Tap **Settings**.
2. Tap **Display>Brightness level**
3. Tap **Adaptive brightness** to automatically adjust the backlight intensity, or slide adjustment bar to set the backlight intensity.

## Audio features

EDA70-X is equipped with speaker, mic and software utilities for volume setting.

### Adjusting the ringtone volume for calls and messages

With the volume key on the side of the terminal, you can quickly adjust the ringtone volume.



**Note:** Volume key can only adjust ringtone volume for calls and messages. To adjust volumes of other sound, open **Settings > Sound**.

## Chapter 1: Product Features of ScanPal Series EDA70-X Terminal

1. Press the button on the right side of the terminal ( $\Delta$ or $\nabla$ ). Volume bar will show on the screen.

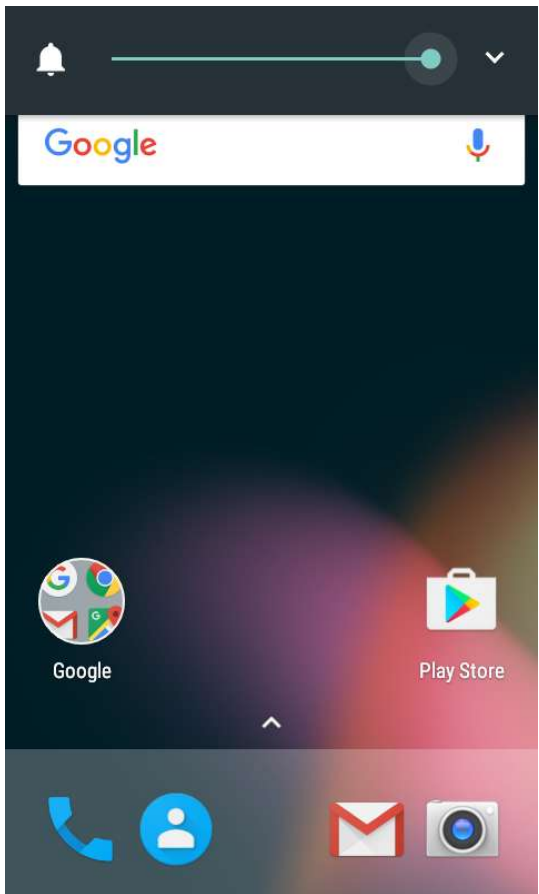

2. Adjust the volume by pressing volume button or slide volume bar.
3. Hold down the volume button or pull the volume indicator to the extreme left to activate vibration mode.

## Enabling vibration mode

You can set the terminal to vibration/silence mode in the office.

Method 1: Long press the volume button or drag the volume indicator to the extreme left to activate vibration mode.

Method 2:

1. Long press the **power** button. Power options will be displayed on the screen:

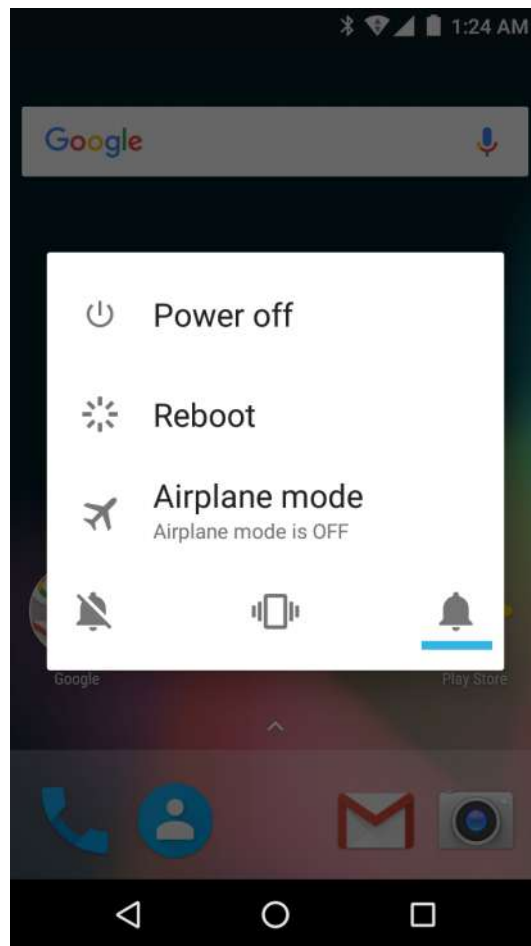

2. Tap  Enabling vibration mode.

## Audio settings

This chapter will describe about audio and sound settings. To change audio setting, go to **Settings > Sound**.

### Audio and sound settings

Settings	Description
Media Volume	Use the volume adjustment bar to set the volume for: Music, videos, games and other medias.
Alarm Volume	Use the volume adjustment bar to set the volume for: Alarm and alert tones
Ring Volume	Use the volume adjustment bar to set the volume for: Ringtones for calls and message notifications. They can also be adjusted by the volume button on the side of the phone.
Also vibrate for calls (Model EDA70-3)	If checked, the terminal will vibrates when a call is in
Do not disturb	Could adjust do not disturb rules
Phone ringtone (Model EDA70-3)	Select a ringtone
Default notification ringtone	Select notifications tones
Default alarm ringtone	Select alarm ringtone
Emergency broadcasts	Set community broadcasts
Other sounds	Set whether to turn on dial pad touch tones, lock screen tone, charging tone, touch tones, and touch vibration.
Cast	Cast the device screen onto a specific device

## Inserting SD card

You can use a SD card to expand the memory or to install software. Honeywell recommend the using of Single Level Cell (SLC) graded SD memory card or SDHC memory card in order to achieve optimum performance and durability.



**Note:** format the memory card when you use it for the first time.

1. Turn off the terminal.
2. Press down the battery cover safety button to move the lock to the unlock position at right;
3. Open the battery cover with the battery cover buckle handle;
4. Pull out the battery (First open the battery connector side, then pull out the battery)
5. Insert the SD card;
6. Insert the battery (first insert one end before pressing the other end in order for it to be connected to the device);
7. Press to lock the battery cover
8. Press down the battery cover and slide the battery cover buckle handle to lock it.

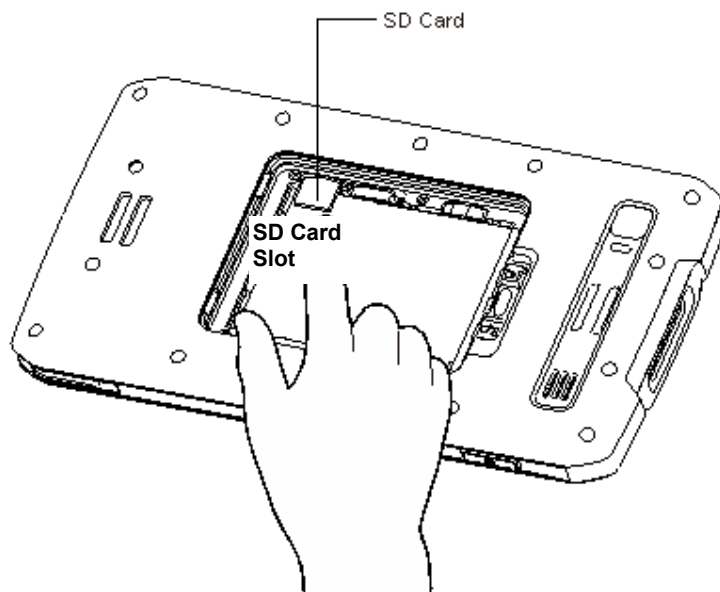

9. Switch on the device

## File transfer

Files can be transferred between the terminal and a computer by using USB CUP. By connecting the terminal to a computer with USB CUP, you can view the files in the terminal, or transfer the files to the computer, or transfer files from the computer to the terminal. If you transfer files with a Mac computer, you need to use Android File Transfer app (it can be download via [www.android.com/filetransfer](http://www.android.com/filetransfer))

The terminal will connect with charging port as default. You can choose MTP (Media Transfer Protocol) or PTP (Picture Transfer Protocol) for connection. If you mainly transfer camera photos, you can use PTP (Picture Transfer Protocol) connection settings. If the computer with Windows system doesn't support MTP, you can use PTP transmission.



**Note:** EDA70-X supports high-speed USB communication (USB2.0), with maximum data transfer rate at 480 Mbps.



1. Connect EDA70-X to the computer through USB CUP.
2. Select Media device (MTP) or Camera (PTP) on the EDA70-X screen. EDA70-X will set your selection as default selection.
3. View the files stored in EDA70-X from a computer. You can copy, delete or transfer the files between EDA70-X and the computer.

## How to view files on EDA70-X

Users can view the files in EDA70-X and its memory card through File Explorer.



**Note:** Due to system permission issues, some files cannot be opened. Based on your needs, you can select respective apps to open the file.

1. Tap or pull upward  >File manager 
2. Tap the folder name or file name to open the file.

## **EDA70-X Accessories**

EDA70-X terminal is equipped with original battery. All other accessories require separate order and shipment. If necessary, please contact your local sales representatives.

**Please refer to EDA70 Accessory Guide for EDA70-X Accessories and Description**

## 2 User interface and applications

This chapter introduces the Android system user interface, and how to interact with the screen. Users can also learn about a variety of Honeywell applications on the terminal through this chapter.



# User interface

Android 7.1 operating system user interface provides users with a perfect touch and easy navigation experience.

## The main interface

After turning on the terminal and setting up your preferred language, the main interface will be displayed on the screen first.

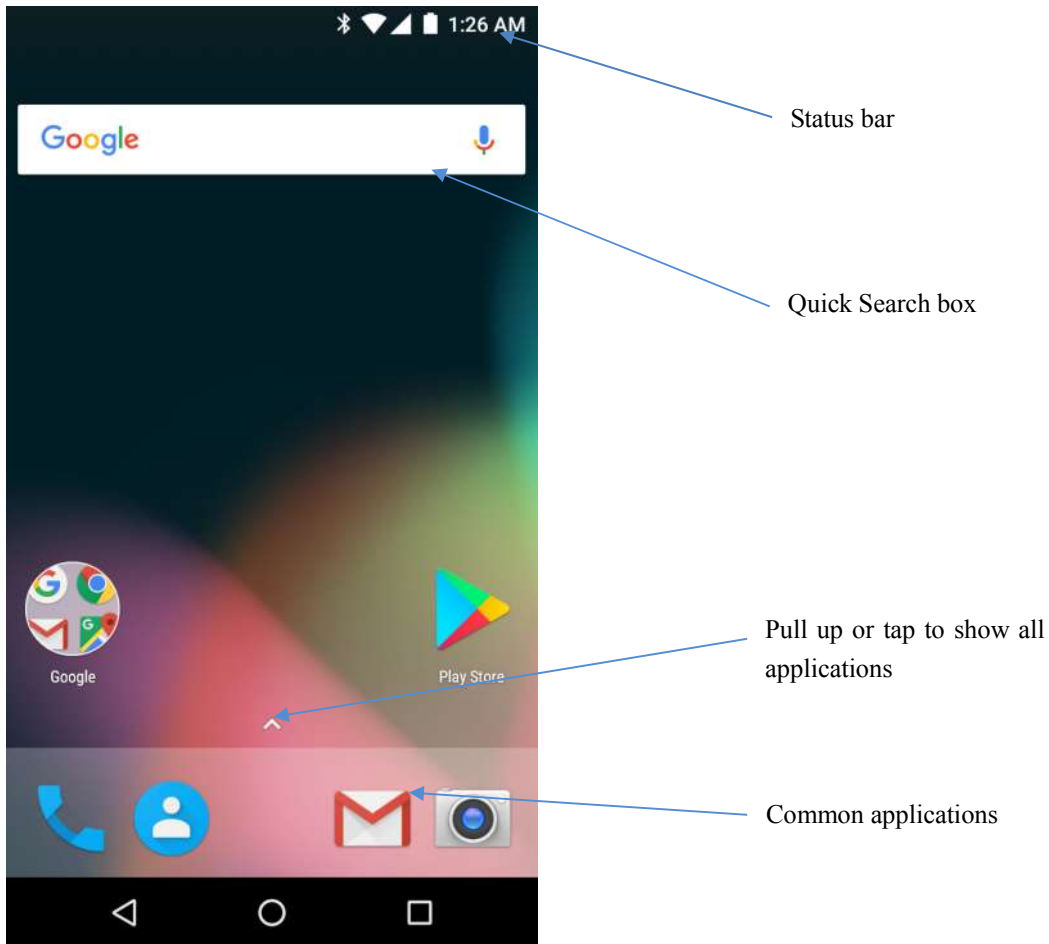

### The main interface description

Name	Description
Status bar	The left side of the status bar displays system messages sent by the application, such as information notifications. The right of the status bar displays the current wireless and network connection status and remaining battery power.
Common applications	The applications on this bar will be displayed on the main interface. <b>All Applications</b> option is in the middle of the common application bar.

## Chapter 2: User interface and applications

---

Search bar







Use Google Search to search on the web or the terminal.

---

## Navigation and function keys

There are navigation and function keys below the common applications in the main interface of EDA70-X; other function keys are on the two sides of the terminal.





### Navigation and function keys

Keys	Description	Functions
	Return	Return to the previous screen
	Function Key	Enter the recent tasks
	Home Key	Return to the main interface
	Volume	Increase or decrease the speaker volume
	Scan Button	Press and hold to scan
	Power key	Power On/Off the Device, lock the screen

















## Status bar icons

Status and notification icons display the current network connections, power, notifications and sound settings. Please refer the following table for detailed status bar icons:

### Status and notification icons:

Icons	Description	Icons	Description
	Incomplete calendar events		Sound is disabled
	Not ringing alarm clock; alarm clock set		Vibration mode has been enabled

## Chapter 2: User interface and applications

	New text messages or multimedia information		Battery power is 100% full
	Text messages or multimedia information transmission failed		Being in charge with external power supply
	New mails		Airplane mode is enabled
	The terminal is connected to the computer via USB cable		EDA70-X is syncing with a Bluetooth-enabled device
	ADB has been enabled (USB troubleshooting has been enabled)		Bluetooth has been enabled
	Data Sync		Wi-Fi signal is adequate
	Sync or account logon failed		Wi-Fi is connected, but with no signal
	Memory card is full		Network connected

### KeyRemap

Users can change the default functions of the left and right scanning buttons.

1. Tap **Settings > Key Remap**.
2. Touch the keys you want to redefine.
3. Tap **KEYS** or **APPS** to view options.
4. Select the required functions for the key. The new functions selected will be displayed under the name of the key.

## Viewing system messages

Users can view EDA70-X's system messages in the notification page.

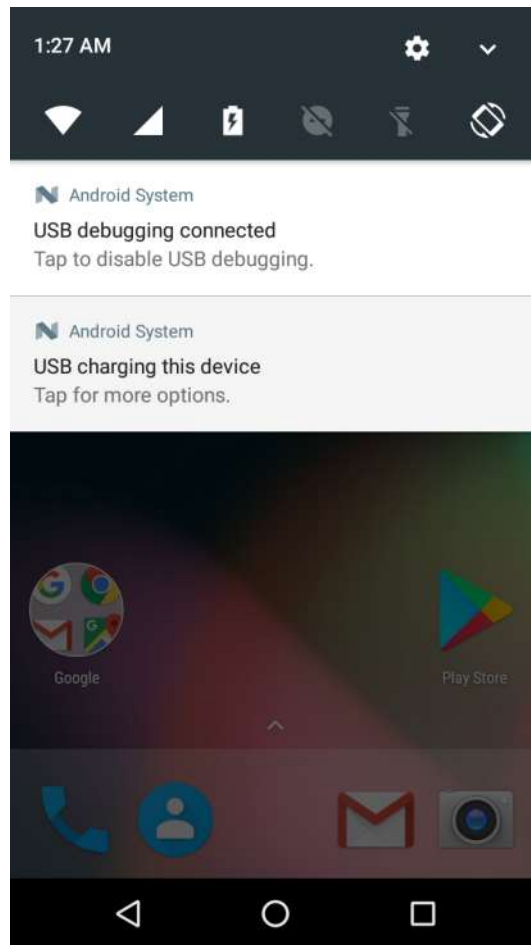

- Open the notification page: swipe down from the top of the screen.
- Close the notification page: swipe up from the bottom of the screen or tap **Return key** or **Home key**.

## Managing system messages

When the applications send system messages to EDA70-X, users can manage them quickly.

1. When the system message icon appears, swipe down the screen.
2. To manage the system message, touch it. The respective application will be opened for users to manage it.
  - Swipe the system message to the side to clear it.
  - Slide the message to the left to set it.

### Personalizing the main interface

You can add application icons to either one of the main interface to open these applications more quickly.

1. Tap or pull upward . To display **All applications**.
2. To move the application icon to the main interface: long press the icons to be added to the main interface, then slide your finger to place it on either one of the main interface.  
  
To move the widget icon to the main interface: long press the desktop- > widget- > long press the widget icon, then slide your finger to place the control icon on either one of the main interface.
3. To remove the applications or widgets from the main interface: long press the icons and slide to X Remove on the top of the interface.
4. Long press the blank area on the desktop, and display menu WALLPAPERS, WIDGETS and SETTINGS.

### Customizing common applications

Users can add applications to the common application bar to open these applications more quickly.

1. Tap or pull upward . To display **All applications**.
2. To add application icon to the common application bar: long press the application to be added, and then slide your finger to put the icon to the common application bar.
3. To remove application icon from the common application bar: long press the icons in the common application bar and slide it to the **X** remove on the top of the interface.

### Using Google™ Search

Use Google search engine at the top of the interface to help users find any information on the terminal or the internet.

1. In any of the main screens, tap Google search box and enter search object. The search results on the terminal (such as applications and contacts) will also appear on the network search result.
2. Tap a search prompt to start the search now, or simply tap the arrow to enter it into the search box without searching immediately.

### Touch screen gestures

Use your finger can operate applications, menus, on-screen keyboard and other functions on the interface.

- Tap a function or application to select or start it.
- To enter a name or password, touch the place to enter and on-screen keyboard will appear for input.

Other touch screen gestures include:

- Long press: press an icon and hold until the system reacts.
- Drag: Press an icon, and then move your finger across the screen to the destination. For example: With dragging method, you can rearrange some shortcuts on the main interface.
- Swipe or slide: Quickly move your finger on the screen and keep your finger touching on the screen. For example, users can swipe the home screen to the left or right to view other home screens.
- Double-click: tap twice rapidly in a row on the map or other interface to enlarge it. Double-click again to return to the original size.
- Kneading: In some applications, subjects can be zoomed out by kneading two fingers on the screen, or zoom in by expanding two fingers.

### Setting timezones













EDA70-X can automatically sync the time and date according to the network. Users can also set timezones for their regions manually.

1. Open **Settings**.
2. Tap **Date & Time**.
3. **Automatic time zone**.
4. Tap **Select time zone** and tap the timezone for your region.

## Honeywell applications

Honeywell helps users troubleshoot and connect the terminals to other devices and networks. Tap or pull upward  to show the applications below. For more details, please visit: [www.honeywellaidc.com](http://www.honeywellaidc.com).

### Honeywell software applications available on EDA70-X

Icons	Applications	Descriptions
	Demos	Demo and more included, allows testing and using functions like scanning.
	ConfigApps	Prohibit/use and uninstallation of applications
	Configure Autorun	Autorun application when the device is being activated
	Backup	Backup and restore user data and Settings
	BattMon	Monitors battery-charging status
	Diagnostic Information	Check equipment information, Honeywell applications, radio frequency information, RAM and scanner
	EZConfig	Configure equipment and applications through barcode and configuration documents
	File Browser	View files stored in the device
	IPConfig	View and set IP address
	LogView	View log information
	Ping	Network diagnostic tool to test whether the network is connected
	Reboot	Used to restart the device



## Chapter 2: User interface and applications



Route

View routing information



Wi-Fi info

View Wi-Fi information



Wi-Fi Radio Settings

It's mainly to set Wi-Fi low power dissipation and Wi-Fi roaming switch threshold

## Download Enterprise Application Lock (Applock)

Applock is an Android application which allows you to configure the apps that may or may not be allowed. The User Guide and installation procedure for Applock may be downloaded via: [www.honeywellaidc.com](http://www.honeywellaidc.com)

## Unlocking developer options

If you are a developer for EDA70-X, you can easily unlock developer options. Developer options can help you test and troubleshoot during the process of developing EDA70-X. After Developer options is unlocked, the system menu will present developer option connections.

1. Tap **Settings**.
2. Tap **About phone**.
3. Click the **Build number** 7 times and notification as " You are now a developer!" will appear.

## GMS

EDA70-X joined in GMS packages of Google. The App includes Maps, Voice Search, Drive, Photos, Chrome, Duo, Gmail, Google, Play store, Play Music, Play Movies, YouTube.

# 3 Scan Function

This chapter describes how to scan barcodes and set scan functions.

## Scan Function

Integrated scanner enables reading for 1D and 2D barcode, composite code and postcode. It supports comprehensive, highly flexible scanning in real applications. Imaging Engine can capture black and white images, such as signatures and damaged inventory lists.

### How to transfer data via Android keyboard input

Scan wedge feature enables transferring scanned barcode data to active applications via Android keyboard input. Scan wedge function is enabled by default on EDA70-X. Users can use applications that can accept scan wedge function through scanners or applications. If an application obtains scan function through Barcode Reader API, the scan wedge function will be temporarily disabled.

Users can build customized applications in Software Development Kit (SDK) for ScanPal EDA70-X. Please download SDK at: [www.honeywellaidc.com](http://www.honeywellaidc.com).

#### Processing and settings for scanned data

Processing steps	Respective scan settings	
Decode barcodes	Symbology settings	
Parsing the barcodes as ISO8859-1	Symbology settings	
Special barcodes detected activate special actions, rather than performing the normal operations.	Data processing settings	Start your browser Scan to Intent EZConfig enabled
Converted to the selected character set	Data processing settings	Character set

Add a prefix and suffix to make the data string in the following order:

- Prefix
- Sign prefix                      Data                      Prefix
- Barcode data                      processing                      Sign prefix
- Suffix                                      settings                      Suffix

Parsing the replacement for prefix and suffix string

Activate Total Freedom plug-in	Data processing settings	Data editing plug in
Input the final data as Android Key Events	Data processing settings	wedge

Prefix and suffix will be replaced within the string value.

**Prefix and suffix parsing**

Substring	Replacement character code	Wedge in form of KeyEvent
\r	13	No
\n	10	Yes
\t	9	Yes
\\	'\'	No

**Changing scan settings**

Changes made to the default file apply for all non-document applications.

1. Tap **Settings**.
2. Tap **Scan Settings**.
3. Tap **Internal Scanner**.
4. Tap **DefaultProfile**.
5. Select **Data Processing Settings**, **Symbology Settings**, **Decode Settings**, **Imager Settings**, **Trigger Settings** or **Notification Settings**.
6. Modify the setting to meet application needs.

## Restoring default scan settings

Users can easily cancel all the changes made to default folder and restore the factory defaults.



**Note:** Restore factory defaults for a certain setting, all the settings under this folder will be restored to factory defaults.

1. Tap the icon  on the upright of any Scan Settings interface.
2. Tap **Restore all defaults**.

## Scanner default settings

Study the following table to learn about Data Processing Settings, Symbology Settings, Decode Settings, Imager Settings, and Trigger Settings and Notification Settings.

### Data processing settings

Use data processing settings to set the barcode data processing patterns for EDA70-X.

#### Data processing settings

Settings	Description	Default
Wedge	Enable or disable the transferring of barcode data as Android Events when sending data to the application.	Enabled
Character set	<p>Explain the selected character set when the barcode is a character, options including:</p> <ul style="list-style-type: none"> <li>• ISO-8859-1</li> <li>• US-ASCII</li> <li>• UTF-16</li> <li>• UTF-16BE</li> <li>• UTF-16LE</li> <li>• UTF-8</li> </ul> <p>The related BarCodeReader attributes:</p> <p>PROPERTY_DATA_PROCESSOR_CHARSET</p>	ISO-8859-1

Prefix	Define the character to be added in front of the decoding barcodes	No
Suffix	Define the character to be added at the end of the decoding barcodes	No
Data editing plugin	Specify a free plug-in for data editing	No
Character prefix	Specify a character prefix to decode the barcode data <ul style="list-style-type: none"> <li>• None</li> <li>• Honeywell</li> <li>• AIM</li> </ul>	No
Start your browser	To open or close URL barcode, if the barcode start with http:// or https://, the browser will open the respective URL The related BarCodeReader attributes: PROPERTY_DATA_PROCESSOR_LAUNCH- BROWSER	Enabled
Scan Intent	Enable or disable scan processing for specified targets. Apply the barcode as the following format <pre> '/' ACTION  '/' intent-suffix '\$' extra-data Where:  Additional operations and data include the following characters, to enable Intent or respective applications  Intent action: "com.honeywell.scantointent.intent.action."+ ACTION  Intent extra "com.honeywell.scantointent.intent.extra.DATA" contains the remainder of the bar code data after the first '\$' character.  The related BarCodeReader attributes:  PROPERTY_DATA_PROCESSOR_SCAN_TO_INTENT </pre>	Enabled
Start EZ Config	Enable or disable specifying EZ Config operations to barcode. Adopt Aztec code and include specified header data. The related BarCodeReader attributes: PROPERTY_DATA_PROCESSOR_LAUNCH_EZ_CONFIG	Enabled

### Symbology settings

Enable or disable a barcode symbology with Symbology Settings. Tap on a symbol to view and modify the configuration parameters of the symbol.

#### Symbology settings

Settings	Default
Code 128	Enabled
GS1-128	Enabled
Code 39	Enabled
Datamatrix	Enabled
UPC-A	Enabled
UPC-E	Disabled
EAN-8	Disabled
EAN-13	Enabled
Aztec	Enabled
China Post	Disabled
Codabar	Enabled
Codablock A	Disabled
Codablock F	Disabled
Code 11	Disabled
Code 93	Disabled



Composite	Disabled
Han Xin	Disabled
IATA 2 of 5	Disabled
Interleaved 2 of 5	Enabled
Korean Post	Disabled
Matrix 2 of 5	Disabled
Maxicode	Disabled
Micro PDF 417	Disabled
MSI	Disabled
PDF 417	Disabled
QR Code	Enabled
RSS (GS1)	Disabled
Standard 2 of 5	Disabled
Telepen	Disabled
TLC 39	Disabled
Trioptic	Disabled
2D Postal Settings	Disabled
OCR	Disabled

### Image settings

There should be no need for users to change image color rendering. Covering the recommended value is disabled by default. Recommended image settings can be applied in many environments; only the users who have more in-depth understanding on the image can change the settings.

### Trigger settings

Trigger settings can set up the using patterns for scan key.

#### Trigger settings

Settings	Description	Default
Decoding timeout	If the scan trigger is held down but decoding is not successfully performed, Scanning will automatically shut down after 20 seconds	20

## Notification settings

You can set up the responses during scanning process for EDA70-X in the notification settings.

### Notification settings

Settings	Description	Default
Good Read Notification	Enable or disable Good Read Notification. Notification includes green indicator, short beep and optional short vibration	Enabled
Bad Read Notification	Enable or disable Fail to Read notification. Notification includes red indicator, failure beep and optional short vibration	Disabled
Vibrate Enabled	Regardless of succeeding or failing to read, turn on or off the phone vibrations	Disabled

## Scanning barcodes

Scan engine will emit scanning beams for accurate barcode aiming. It will also support a full range of 360° scanning, which will make barcode scanning more convenient.



**Note:** Before scanning a barcode, you only need to enable the desired barcode symbology in the settings.

1. Tap or pull upward  >**Demos**>**ScanDemo**.
2. Align the scanning window with the barcode and stably place the terminal a few inches away from the barcode.
3. Press one of the scan keys or tap **Scan** on the interface. Make sure the entire barcode is within the scanning beam range.

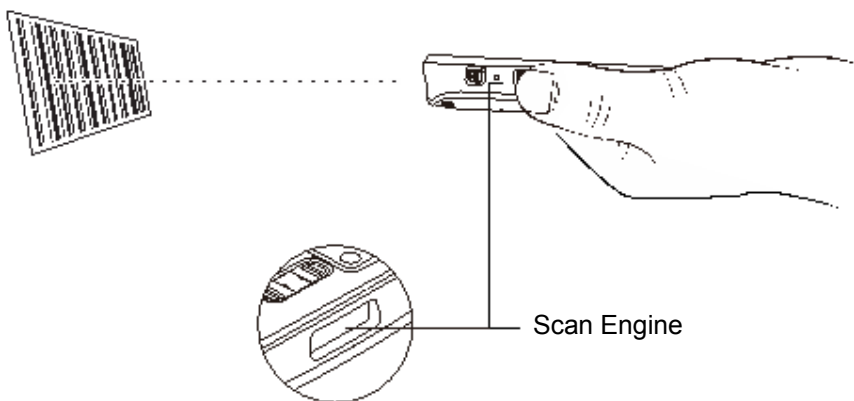

When the scanning is successfully completed, you will hear a "beep" sound, and the Good Read LED will open immediately.

# 4 Using Telecommunication Function

You can use the phone function of the terminal (Only for EDA70-3 WWAN version) to make and receive calls, and to transmit data via wireless network as well.

## Telecommunication Function

The phone function of the terminal is realized with a speaker and a microphone. The phone function also supports a Bluetooth headset or hands-free device. The EDA70 will use loudspeaker mode without connecting bluetooth headsets or other external audio devices. The phone function is enabled by default.

This terminal supports the following network types:

- GSM&EDGE: Band2/Band3/Band5/Band8
- WCDMA: Band1/Band2/Band4/Band5/Band8
- FDD-LTE: Band1/Band2/Band3/Band4/Band7/Band20

When users enable the phone function and activate the service through wireless carriers, they can customize the phone features and network settings in the Mobile Network interface in Settings.



**Note: EDA70-3 WWAN version supports automatic system time setting with network messages and timezone messages (NITZ).**

### Activating calls

Calls can be activated by inserting Micro SIM card in the terminal. Micro SIM card can be purchased from the network service provider.

1. Turn off the terminal.
2. Press down the battery cover safety button to move the lock to the unlock position at right;
3. Unlock the battery cover using its lock handle;
4. Remove the battery (remove it from its bottom end before pulling it out);
5. Open the cover of SIM card slot.
6. Insert the SIM card from the SIM card slot until hearing a click.
7. Press down the cover of SIM card.
8. Insert the battery (Insert the connector side first, then press the battery down to establish connection between the battery and the phone).
9. Press down the battery cover (Insert the connector side first, then press down the battery cover).
10. Move the battery cover safety lock to the lock position at left.
11. Turn on the terminal.

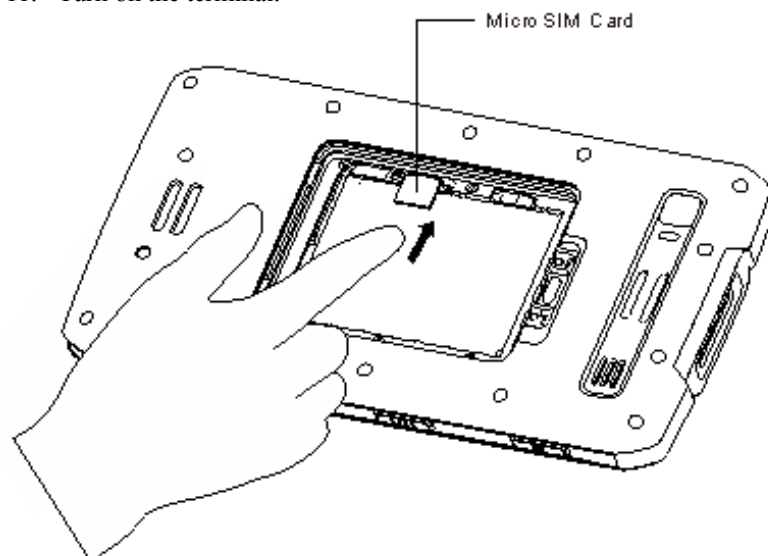

### Making a call

After the phone is successfully activated, you can make calls.

1. Click  on the main screen or display screen.



If the screen shows numbers list and not telephone keyboard, lightly press  to return to the keyboard;

2. Enter the numbers and lightly press  below to make the call;
3. To end the call, press .

### Answering a call

When a user receives an incoming call, the screen will be illuminated with the caller's number displayed. All calls are recorded in the call log. If you have missed calls, you will receive reminding notifications.

When there is an incoming call, tap the white phone icon and slide to any one of the following icons:

- Answer the call: 
- Hang up: 
- Send a message from the default list: 

### Switching applications during a call

Users can switch applications during a call. For example, users can use the Contacts application to find contact information during a call.



**Note: If the user only has WWAN connection, the applications requiring data connection may not be able to obtain network data during the call. Due to restrictions from network carriers, you can not receive multiple simultaneous calls and connections and voice calls will get priority. For more information, please contact your network carrier.**



During the call, tap the icon of other applications on the main interface or application interface to run the application, while the call icon shows in the status bar.

## Making an emergency call

If SIM card has been misplaced, or if the user does not have valid SIM card, the user can still make emergency calls. Under both circumstances the device will show no service access, but calls to emergency numbers (e.g. 112, 911, 000, 08, 118, 119 or 999) will still be connected.

## Configuring call settings

Users can customize phone settings, including display options, Sounds and vibration, Quick responses, Speed dial Settings, Calls, Call blocking, Accessibility.

1. Tap .
2. Tap  Settings to show Call Settings menu.
3. Change the settings based on your needs.



# 5 Using Camera

This chapter describes how to use a color camera to take photos and videos.

## Color camera

EDA70-X is equipped with 5 megapixels color camera which can be used to take photos and videos. The camera and flash light are located on the back of the terminal. Tap Photos



Gallery app to view all the photos and videos stored on the terminal.

## Adjusting camera and video settings

Adjust the camera and video settings in the Camera apps.

### Zooming

Focus adjustment is realized by zooming actions of the fingers on the screen. Place two fingers on the screen at the same time, then:

- Separate the two fingers in opposite directions to zoom in the images (enlarge objects).
- Fold the two fingers in opposite directions to zoom out the images

### Changing camera settings

In order to obtain the best results when taking photos, users can change the camera settings beforehand.

1. Tap All Applications and then tap Camera 
2. Tap the Setting icon on the top right to view Camera Options.
3. Tap HDR or any icons to change the basic settings of the camera.
  - When HDR is enabled, the terminal will automatically capture multiple photos and composite them into one to achieve the best possible image quality.
  - Enable or disable various options, like viewfinder mode, storage location and image size.





## Taking photos

1. Tap All Applications and then tap Camera 

2. Take the screen as a viewfinder and move the terminal until you get the images you want to capture.
3. Tap the screen to focus. By default, the camera automatically senses the ambient light, and the flashlight will be opened if necessary.
4. Press the camera key  to take photos



## Shooting videos

This section describes how to use the camera function to shoot videos.

1. Tap All Applications and then tap Camera .
2. Tap Camera Shooting Options on the bottom right .
3. Tap  to choose videos
4. Tap  to start video shooting. To adjust the focus, you can knead two fingers on the screen; to capture images, you can tap on the screen for instant capturing during video shooting process.
5. To stop video shooting, tap .

## Changing video settings

In order to obtain the best results when shooting videos, users can change the camera settings beforehand.

1. Tap All Applications and then tap Camera .
2. Tap .
3. Tap settings on the top right corner or slide to the right to view Video Options.
4. Tap any other positions of the screen to enable or disable Camera Options.

# 6 Configuring Terminal

This Chapter deals with configuration of EDA70-X. The user can also learn how to configure network communication and wireless security.

## Terminal configurations

Users can configure many parameters for the terminal, such as barcode symbologies to be decoded or network settings. These parameters set by the user decide how the terminal works.

Users can configure the terminal in Application Settings.

### Setting launch applications

Set the applications using the application menu.

Tap **Settings**.

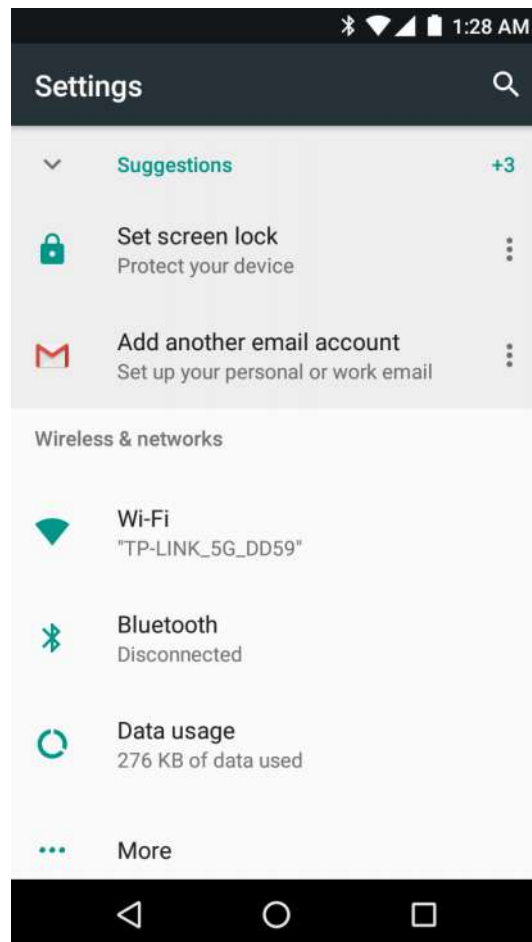

### Structure of the Application Settings

The section describes the structure of Application Settings to make it easier for users to quickly locate respective specifications.

## Chapter 6: Configuring Terminal

### Suggestions

Automatically recommend quick access through intelligent pre-judgment of user's needs.

### Wireless & networks

Settings	Introductions
Wi-Fi	To enable or disable Wi-Fi radios. When Wi-Fi is enabled, available Wi-Fi networks can be viewed by tapping this bar.
Mobile data (only supported by RDA70-3 WWAN)	(This menu will be displayed after inserting SIM card) Enable or disable mobile data. When it is enabled, tap the bar to view available mobile network).
Bluetooth	To enable or disable Bluetooth radios. When Bluetooth connection is enabled, Bluetooth-enabled devices within the range can be viewed by tapping this bar.
Data usage	Displays the current usage of flow rate, including Wi-Fi and Cellular data. (Cellular data will displayed after sim card is inserted).
More...	<p>Airplane mode: to enable or disable Airplane mode.</p> <p>Wi-Fi Calling: to telephone through Wi-Fi network after it is being enabled.</p> <p>NFC: enabling NFC allows NFC tag information to be read when the terminal touches NFC tag.</p> <p>Android Beam: when NFC is enabled, this function allows users to send the application contents from the terminal directly to another NFC-supported device when the two get closer.</p> <p>Tethering &amp; Portable Hotspot: a handheld device can be used as a wireless router to radiate the wireless network, and then other WLAN-enabled device can receive it (only supported by EDA70-3 WWAN).</p> <p>VPN: Set a password for accessing the virtual private network.</p> <p>Cellular Networks: mobile network setting (only supported by EDA70-3 WWAN)</p> <p>Mobile Plan: plans provided by network carriers.</p> <p>Network Settings reset: reset all network setting.</p>

**Device**

<b>Settings</b>	<b>Introductions</b>
Sound	Set sound for calls and notifications, including the tone and volume.
Display	Set screen brightness, wallpaper, screen timeout, font size and screen rotation.
Notifications	Set whether the app allows notifications to be sent
Storage	Shows the remaining memory space.
Battery	Shows battery usage data and the current battery status.
Apps	Shows applications downloaded and on the run.
Memory	Display memory usage
Users	Add toggle user

**Personal**

<b>Settings</b>	<b>Introductions</b>
Location	To enable or disable location information (Google and GPS satellite data).
Security	Set screen lock and administrator privileges, including application installation and data storage security.
Accounts	Set up an e-mail account.
Google	Related services of Google
Language & input	Select the current language and the default keyboard. Set automatic input function, such as: capitalization and punctuation. Set the cursor speed for external mouse or touch screen.
Backup & reset	Factory Data Reset.

## Chapter 6: Configuring Terminal

### Honeywell Settings

Settings	Introductions
Key Remap	Redefines left scan button, right scan button, middle scan button and P1, P2 buttons. For more information please refer to <i>Mapping Button</i> .
Honeywell Battery LED	Configuring battery LED lighting modes.
Scan Settings	Configure ScanPal EDA70-X imager. For more help, please refer to <i>changing scan settings</i> .
Logger	Activates Android Logcat and Linux Kernel log services to facilitate identification of problems during the device's operation.
Smart sensors	Integrated sensor allows better power management.

### System

Settings	Introductions
Date & Time	Configure all time and date settings.
Scheduled Power On and Off	Set scheduled power on and off
Accessibility	Set auxiliary function level, for example: large font and text-to-speech output.
Printing	Configure printing options.
About phone	Shows information about the terminal system.



## Network communication

Users can connect the terminal to wireless and wired networks. Users can get the terminal connected via the following ways:

- 802.11 radios
- Bluetooth
- USB

### Connecting to Wi-Fi networks

When communicating through wireless networks, GEDA70-X transfer data through 802.11 radios. Before connecting to a Wi-Fi network, users need to know the Security Protocol of the network and the certificates it required. Usually, 802.11 radio is disabled by default.

1. Enter **Settings**>Wi-Fi.
2. When the WLAN switch turns blue, tapping the WLAN bar will display the detected network list.
3. To quickly connect to a network via WLAN Protected Access (WPS), tap . To search the network outside of the list, slide to the end of the list and tap **Add network** and enter the network name.
4. Tap on a network name to view its details.

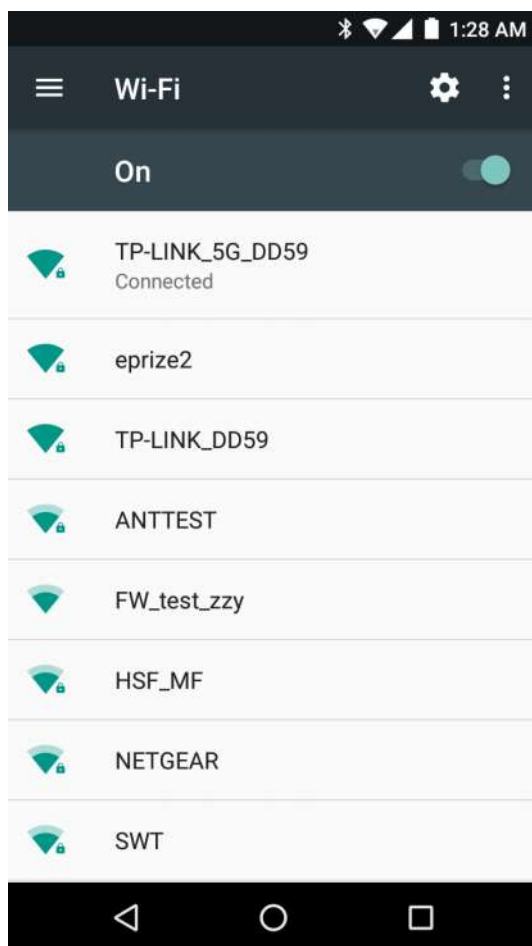

If the network is secure, a form will pop up asking you to fill in the necessary information (for example: certificate name, password or other credentials). To connect to a secure network, enter the required information, and then tap **Connect**.

- To leave the network that has been connected, tap **Forget**. For example, users can choose to forget a network that they won't use again.
- To close the network information screen, tap **Cancel**.

### Configuring Wi-Fi network proxy servers

If users need to connect to network resources through a proxy server, they need to configure a proxy server for each Wi-Fi network added. By default, none of the Wi-Fi networks added by users has done proxy server settings.



**Note: Proxy server settings only apply to the Wi-Fi networks that users modified. Users have to set proxy servers for each network that requires the using of proxy server.**

1. Enter Application Settings screen, tap Wi-Fi to show available Wi-Fi networks.
2. Long press the network name, then tap **Connect the Network**, then a network setting list will pop up.
3. Choose Show Advanced Options at the bottom of the network setting list.
4. If the network does not have proxy server settings, tap **None** on the proxy server setting list, and then tap **Manual Settings**.

5. Enter the network proxy server settings.
6. Tap **Save**.

### **Disable Wi-Fi notifications**

Wi-Fi is enabled by default. Users will receive notifications in the Status Bar when the terminal finds wireless networks. Users can disable these notifications.

1. Enter Application Settings screen.
2. Tap WLAN bar.
3. Tap the Settings icon on the top right.
4. Tap **Advanced** to display Wi-Fi Advanced Menu.
5. Uncheck the **Network notification** to disable Wi-Fi Notifications.

### Connecting to a virtual private network

The terminal supports connection to virtual private networks (VPN). This section describes how to add and connect to VPN. To configure a VPN, users must consult your network administrator. Users can view and change VPN settings in the Application Settings.



**Note:** Before accessing VPN, users need to set a lock screen password.

#### Add VPN

Before connecting to a VPN, users must first add the relevant information of the VPN.

1. Enter Application Settings screen.
2. Tap **More** under **Wireless and Networks**.
3. Tap **VPN**.
4. Tap Adding +.
5. Input the VPN information.
6. Tap **Save**, and VPN name will be displayed in the list.

#### Connect to VPN

1. Enter Application Settings screen.
2. Tap **More** under **Wireless and Network**.
3. Tap **VPN**.
4. Tap the VPN name in the list, and enter the certificate information based on the tips.
5. Tap **Connect**. The terminal gets connected to the VPN, and the status icons and notification will be displayed. To disconnect from the VPN, tap the notification.

#### Edit VPN information

1. Enter Application Settings screen.
2. Tap **More** under **Wireless and Network**.
3. Tap **VPN**.
4. Long press the name of the VPN to be edited and select **Editing Networks** from the list.
5. Edit VPN information based on your needs.
6. Tap **Save** after editing.

## Wireless Security

The terminal provides the following security solutions for users' wireless network.

- WPA2™
- WPA
- 802.1x
- WEP

Before setting up security program, you must first enable the radio and set the date and SSID on the terminal. To use 802.1x program, users must download a root certificate to the terminal. To use Transport Layer Security protocol (TLS) together with 802.1x , users also need to download a user certificate first.

View and configure all of the wireless security settings in the Application Settings screen.

### Certificates

Users can use digital certificates to identify the terminal's network access or server validation. To identify the device with certificates, users must first install the device to the trusted certification store on the terminal.

Android supports DER encoded X.509 certificate stored in the documents with .crt or .cer extension. Install a valid DER-format certificate. Android also supports X.509 certificate stored in PKCS # 12 key store file with p12 or .pfx extension. To install a valid key storage file with other extensions at the end, users must change the extension to .p12 or .pfx first. If users installed a certificate from the PKCS # 12 key store file, Android will also install the private key certificate or a certificate authority that came with it.

#### Download certificates

To use the certificate, users must first install the certificate to the trusted certification store on the terminal.



**Note:** Some applications that support certificates, such as email and browsers, allow users to install the certificate directly from the application. For more information, please refer to the Help Documentation in the application.

1. Copy the certificate or key storage from computer to the SD card.
2. Install the SD card in the terminal and turn on the terminal.
3. Enter Application Settings, tap **Safety > Install From SD Card**.
4. Tap the name of the certificate or key storage to install. Following the tips to enter the password of the key storage, then tap **OK**.
5. Enter the certificate name and tap **OK**.

### Disable or delete certificates

If the certificate is a stolen one or the organization selected by the user does not trust the certificate, the user can disable or delete the certificate.

1. Enter Application Settings, tap **Safety > Trusted Credentials**. There are two tabs in the Trusted Certificate screen:
  - System tab displays CA certificates installed in ROM.
  - User tab displays CA certificates installed by users.
2. Tap the certificate name to disable or delete it, and the certificate details screen will pop up.
3. Slide the screen down to the bottom, tap **Disable** (system certificates) or **delete** (user certificates).

If necessary, users can enable the disabled system certificate here. For deleted user certificates, users must reinstall it to enable it again.

4. Tap **OK**.

## Bluetooth communication

EDA70-X supports Bluetooth communication, allowing users to get connected with other Bluetooth-enabled devices.

Before searching for and connecting to other Bluetooth-enabled devices, users must enable the Bluetooth radio. By default, Bluetooth radio is disabled.

Bluetooth radio can be restored to its current state by system resetting. If users have reset the system data, they must re-establish the paired devices. Bluetooth status is displayed on the System Icon bar.

### Pairing with a Bluetooth-enabled device

To connect to a Bluetooth-enabled device, users should enable Bluetooth radio first and then choose the device from the detected device list.

1. Enter Application Settings screen.
2. If Bluetooth switch is off, slide it on.
3. Tap **Bluetooth** to display available Bluetooth-enabled device list.

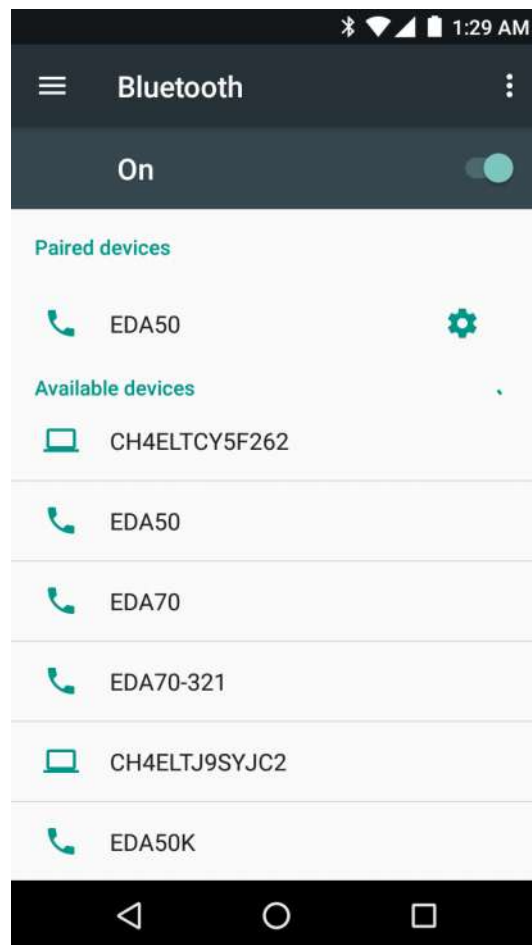

## Chapter 6: Configuring Terminal

- (Optional) If the desired device is not listed, please check if the Bluetooth of that device has been enabled and is detectable, and then tap **Scan Device**.
- Select the device to pair with. After Pairing Dialog Box is displayed, enter the device PIN code, and tap **OK**. When the device and the terminal s have been successfully paired, the device name will appear in the list of paired devices at the top.

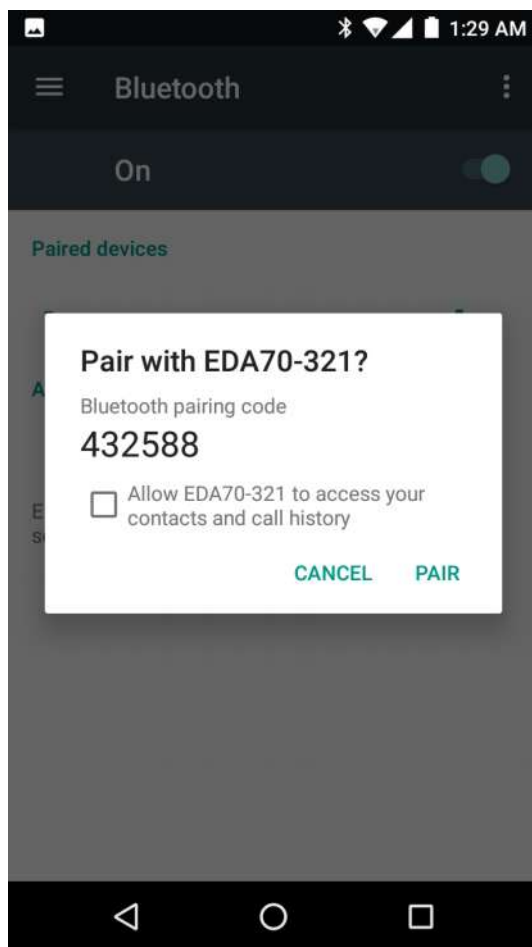

- To disconnect with the paired device, tap the Quick Setting icon beside the device name , and then tap Cancel Pairing.



## Configuring Bluetooth settings

Users can configure for Bluetooth in Application Settings.

1. Enter Application Settings screen, and tap **Bluetooth**.
2. Tap Menu icon  to select one for setting:
  - Refresh.
  - Tap Rename phone to change the name of the terminal. Enter a new name and then tap **Rename**.
  - Tap **Show received files** to view data in the received files.

## Searching for EDA70-X

By default, the device can be searched during Bluetooth is turned on.

## Renaming or disconnecting a paired device

Users can rename or disconnect a paired Bluetooth-enabled device in the Application Settings.

1. Enter Application Settings screen, and tap **Bluetooth**.
2. Tap **Settings** icon in the Paired List .
3. To rename the device, tap **Rename**, enter a new name and click **OK**.  
To disconnect with this device, tap **Cancel save**.

## Communication via USB

By communication via USB, users can transfer data to other devices or receive data from other devices with the following accessories.

- USB CUP cable

For more information about accessories, please contact local resellers.

## Near Field Communication

NFC technology provides short-range wireless data transmission between ScanPal EDA70-X with NFC tags or other NFC-enabled devices near its back.

NFC-enabled ScanPal EDA70-X models support the following operations:

NFC tag read / write mode: The terminal reads digital information from the NFC tag or writes information into NFC tag.



**Note: When in sleep mode (suspend mode) and lock-screen state, NFC radio will be temporarily disabled.**

# 7 Management and Maintenance

This Chapter deals with software upgrade, resetting terminal and maintenance of EDA70-X.

## Upgrading system software

The other system softwares of EDA70-X can be upgraded by downloading ".zip" files from the Technical Support Website. Website: [www.hsmcontactsupport.com](http://www.hsmcontactsupport.com) or [www.honeywellaidc.com](http://www.honeywellaidc.com).

### Upgrading AutoInstall application

1. Copy the upgrade file "EDA70-ota-xxx.zip" to the following EDA70-X's system folder:
  - File Explorer\External Memory Card\Honeywell\Autoinstall
  - IPSM\Honeywell\Autoinstall
2. Tap **All Applications > AutoInstall Settings**.
3. Choose **Packages update**, and ScanPal EDA70-X will restart and install the upgrade file.

### Upgrading composite key

1. Copy the file "EDA70-ota-xxx.zip" to the root directory of the T card.
2. Restart the terminal, when the green light of the device turns on, press and hold the "(left) Scan key" + "Volume-" key at the same time. When the green light turns off, the terminal will automatically select the zip package and install it.
3. After the installation is complete, the terminal will restart automatically.

### Manually upgrading Recovery Menu

1. Copy the file "EDA70-ota-xxx.zip" to the root directory of the T card.
2. Turn off the terminal, press and hold the "Power Key" + "Volume+" key for about 15s, then the phone will enter Recovery Menu.
3. Press "Volume-", and select "Apply update from SD card". Press "Power Key", select the zip file just copied, then press and hold the "Power Key".
4. After the upgrading is completed, it will automatically move to Reboot System Now Menu. Please press the "Power Key" to restart the terminal.

## Restarting the Terminal

If the terminal or an application is locked or doesn't respond when pressing the power key, you need to restart the terminal.

When restarting, the terminal will use the current configuration saved in the flash memory. Try the following ways to restart the terminal:

- **Restarting the system:** Restarts the terminal's operating system
- **Restarting hardware:** If there is no response after pressing the power button, hold it down for 13 seconds to force restart of the device
- **Restore default settings:** Clears all data in the terminal including all applications, data and files except built-in files or data in the movable storage device

### Restarting the system

When an application is not responding, you may need to restart the terminal to resolve the issue.

1. Save the file and close open applications.
2. Press and hold "Power Key" until the following interface displayed:

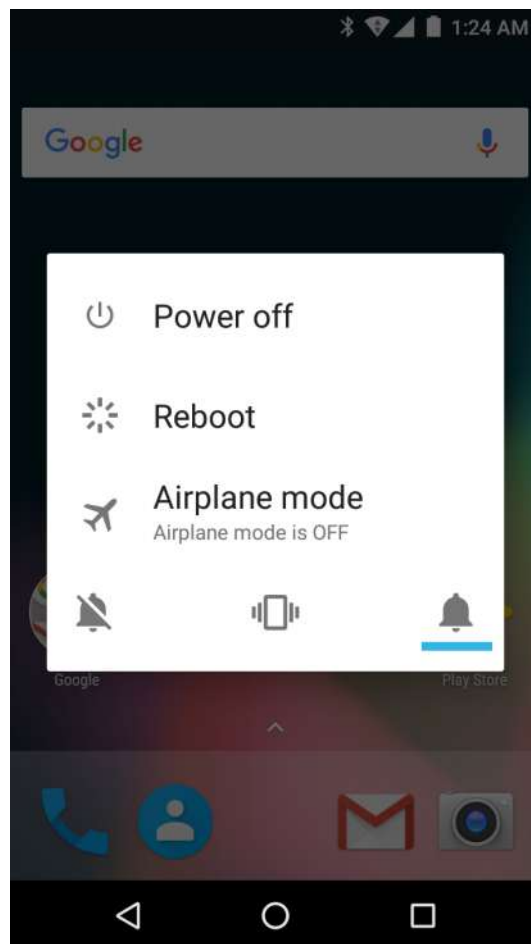

3. Tap **Power off**. EDA70-X is powered off.
4. Press down "Power Key" to restart EDA70-X.

### Restore factory settings

If the terminal appears to be locked, try a cold boot. If resetting is invalid, try to restore factory settings, restart the terminal to make it work again and do troubleshooting later.



**Warning: This action will clear all data in the terminal, including all applications and data, but excluding data stored in flash memory or external storage device.**

1. Tap **Settings**.
2. Tap **Backup & Reset**.
3. Tap **Factory Data Reset**.
4. Tap **Reset Phone**.
5. EDA70-X will restart and automatically clear user data.

### Cleaning the terminal

In order to ensure the terminal in good working condition, you need to clean the scan window, camera and touch screen. Based on the environmental conditions where the terminal is being used, clean these parts at regular intervals. Use a clean, soft cloth which dampened with the following solvents for the cleaning, and quickly wipe it with another piece of clean, soft cloth.

- Acetic acid (10% soluble in water)
- Ethanol (10% soluble in water)
- Neutral soap solution



**Warnings: this product includes non user-serviceable parts inside. Disassembling the product may prevent warranty and cause internal damages to the product.**



**Note: We advise you not to open the battery cover or remove the battery, so as to avoid the liquid flowing into the internal part of the terminal from the SIM card and SD card interface.**

1. Press the **power** key to enter standby mode.
2. Dip a clean cloth in detergent, then wrung out excessive water.
3. Wipe the scanning window, camera and flash area, avoiding touching these areas with hard objects or abrasive materials.
4. Dry the cleaned area.
5. Make sure the terminal is fully dry before using it again.

# 8 Specifications

## Mechanical and environmental specifications

This Chapter provides the physical and environment specifications of EDA70-X

### Product dimensions

Length	214 mm
Width	118 mm
Thickness	21 mm
Weight (with battery)	550 g (with battery)

### Tumble and drop standards

Tumble	200 impacts within 0.5m
Drop	Multiple 1.2 m drops to concrete

### Power and electrical specifications

Battery	Rechargeable Li-ion battery, 3.8 V, 4000mAh
Charging power	5 V, 1.2 A

### Temperature and humidity specifications

Operating temperature	-10 °C ~ 50 °C (14 °F ~ 122 °F)
Storage temperature	-20 °C ~ 60 °C (-4 °F ~ 140 °F)
Relative humidity (during operation)	10% to 90%, non condensing
Environmental sealing	IP64

### **Display specifications**

7.0-inch color LCD/HD1280 x 720 pixel/full-perspective/capacitive touch screen

### **Language Support**

Language Support and not limited to WW English, French, German, Italian, Spanish, Simplified Chinese, Traditional Chinese.

### **Symbolgies Support**

The following symbologies are supported:

#### **1D codes:**

- Codabar
- Code 3 of 9
- Code 11
- Code 32
- Code 93
- Code 128
- EAN-8
- EAN-13
- GS1-128
- Korea Post
- IATA 2 of 5
- Industrial 2 of 5
- Interleaved 2 of 5
- ISBN
- ISBT 128
- Matrix 2 of 5
- MSI Plessey
- EAN.RCC (RSS-14)



- RSS Limited
- RSS Expanded
- Telepen
- Trioptic Code
- UPC-A
- UPC-E

### **2D codes:**

- Aztec Code
- Codablock A
- Codablock F
- DataMatrix
- HanXin
- Maxicode
- Micro PDF 417
- MicroQr
- PDF 417
- QR Code
- TLC39
- OCR-A
- OCR-B

### **Postal codes:**

- Australian Postcode
- Canadian Postcode
- KIX (Dutch) Postcode
- Japanese Postcode
- UK Postcode
- Planet Code
- Postnet
- UsIntelligent
- Info mail
- UPU(ID-tag)

### Scan Depth of Field (DOF)

DOF performance of the product was measured under the following conditions:

- DOF is the distance from the top of scan engine to the barcode
- 23 °C (73 °F), 0 ~ 10K lux
- Clear, high quality barcodes



**Note: If the barcode is not aligned well with the scan engine, reading time and depth of field (DOF) will be affected and the device performance will be decreased.**

	Short range (in/cm)	Long range (in/cm)	Increments (in / cm)
5mil code39/128	2.5 (6.3)	4.3 (10.9)	1.8 (4.6)
13mil UPC-A	2.2 (5.5)	10.5 (27.8)	8.3 (22.3)
6.7mil PDF417	2.2 (5.5)	4.6 (11.7)	2.4 (6.2)
20mil QR	1.5 (4.0)	8.7 (22.0)	7.2 (18.0)

**Honeywell Scanning & Mobility**

9680 Old Bailes Road

Fort Mill, SC 29707

[www.honeywellaidc.com](http://www.honeywellaidc.com)

ScanPal 70 Series terminal for Android User Guide

P/N EDA70-SC-UG Rev.B